

5 PITONES · 5 PINS · 5 PISTONS



► Características técnicas

- Certificado según la Norma Europea EN 1303:2006.
- 5 llaves de latón niquelado.
- Muelles y pitones en acero inoxidable.
- Protección frontal antitaladro.
- Amaestramiento. Llaves iguales.
- Tarjeta personal para copia de llaves.

► Technical specifications

- Certified to the EN 1303:2006 standard.
- 5 nickel plated brass keys.
- Spring and pins in stainless steel.
- Anti-drilling protection.
- Masterkeying, Key alike.
- Personal card for key copying.

► Caractéristiques techniques

- Certifié par la norme européen EN 1303:2006.
- 5 clés en laiton niquelé.
- Ressorts et goupilles en acier inox.
- Protection antiperçage.
- Organigramme. S'entrouvrant.
- Carte de reproduction.

Cilindro doble Key-key cylinder Cylindre clef-clef

REF.	Medidas · Size · Dimension			Excéntrica Cam Panneton	Acabado Finish Finition	Blister Blister Blister
	L =	A	+ B			
C2 5 3232 L	64	32	32	15mm.	■	×
C2 5 3532 L	67	35	32	15mm.	■	
C2 5 3535 L	70	35	35	15mm.	■	×
C2 5 4032 L	72	40	32	15mm.	■	×
C2 5 4532 L	77	45	32	15mm.	■	
C2 5 4040 L	80	40	40	15mm.	■	×
C2 5 5032 L	82	50	32	15mm.	■	
C2 5 4540 L	85	45	40	15mm.	■	
C2 5 4545 L	90	45	45	15mm.	■	
C2 5 5040 L	90	50	40	15mm.	■	
C2 5 6032 L	92	60	32	15mm.	■	
C2 5 5540 L	95	55	40	15mm.	■	
C2 5 6532 L	97	65	32	15mm.	■	
C2 5 5050 L	100	50	50	15mm.	■	
C2 5 6040 L	100	60	40	15mm.	■	
C2 5 6050 L	110	60	50	15mm.	■	
C2 5 7040 L	110	70	40	15mm.	■	
C2 5 3232 N	64	32	32	15mm.	○	×
C2 5 3535 N	70	35	35	15mm.	○	×
C2 5 4032 N	72	40	32	15mm.	○	×
C2 5 4040 N	80	40	40	15mm.	○	×
C2 5 5032 N	82	50	32	15mm.	○	
C2 5 4540 N	85	45	40	15mm.	○	
C2 5 5040 N	90	50	40	15mm.	○	
C2 5 6032 N	92	60	32	15mm.	○	
C2 5 5540 N	95	55	40	15mm.	○	
C2 5 6532 N	97	65	32	15mm.	○	
C2 5 5050 N	100	50	50	15mm.	○	
C2 5 6040 N	100	60	40	15mm.	○	
C2 5 6050 N	110	60	50	15mm.	○	
C2 5 7040 N	110	70	40	15mm.	○	
C2 5 3232 V	64	32	32	15mm.	■	
C2 5 3535 V	70	35	35	15mm.	■	
C2 5 4032 V	72	40	32	15mm.	■	
C2 5 4040 V	80	40	40	15mm.	■	
C2 3 3232 L	64	32	32	13,25mm.	■	
C2 3 4032 L	72	40	32	13,25mm.	■	
C2 3 3232 N	64	32	32	13,25mm.	○	
C2 3 3532 N	67	35	32	13,25mm.	○	
C2 3 3535 N	70	35	35	13,25mm.	○	
C2 3 4032 N	72	40	32	13,25mm.	○	
C2 3 4532 N	77	45	32	13,25mm.	○	
C2 3 4040 N	80	40	40	13,25mm.	○	
C2 3 5032 N	82	50	32	13,25mm.	○	
C2 3 5040 N	90	50	40	13,25mm.	○	
C2 3 6032 N	92	60	32	13,25mm.	○	
C2 3 5540 N	95	55	40	13,25mm.	○	
C2 3 5050 N	100	50	50	13,25mm.	○	
C2 3 7040 N	110	70	40	13,25mm.	○	

Excéntrica · Cam · Panneton

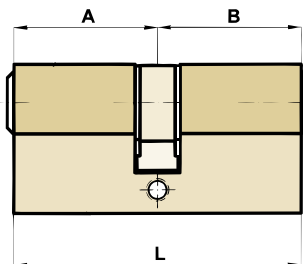
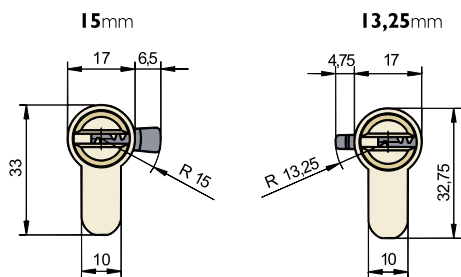

■ Latón, Brass, Laiton ○ Niquelado, Nickel plated, Nickelé ■ Bronce inglés, English bronze, Bronze anglais

Disponibilidad: función doble embrague
With double clutch on request
Débrayable sous commande

Seguridad · Security · Sûreté



Medio cilindro Half cylinder Demi cylindre

REF.	Medidas · Size · Dimension			Excéntrica Cam Panneton	Acabado Finish Finition	Blister Blister Blister
	L =	A +	B			
C2 5 3210 L	42	32	10	15mm.	■	x
C2 5 3510 L	45	35	10	15mm.	■	
C2 5 3210 N	42	32	10	15mm.	⊙	x
C2 5 3510 N	45	35	10	15mm.	⊙	
C2 3 3210 N	42	32	10	13,25mm.	⊙	
C2 3 3510 N	45	35	10	13,25mm.	⊙	
C2 5 3210 BI	42	32	10	15mm.	■	

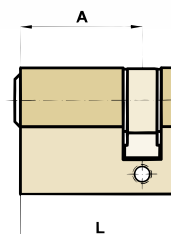

Cilindro con botón Knob cylinder Cylindre à bouton

REF.	Medidas · Size · Dimension			Excéntrica Cam Panneton	Acabado Finish Finition
	L =	A +	B		
C2 5 3232 LB	64	32	32	15mm.	■
C2 5 4032 LB	72	40	32	15mm.	■
C2 5 3232 NB	64	32	32	15mm.	⊙
C2 5 4032 NB	72	40	32	15mm.	⊙
C2 3 3232 NB	64	32	32	13,25mm.	⊙

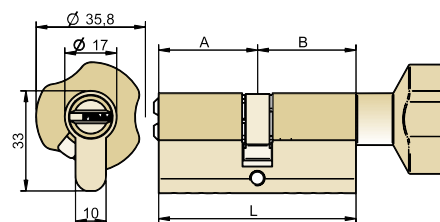

Botón desmontable y disponible desde 32 hasta 65mm (cota B).
Removable knob; available from 32mm up to 65mm.
Bouton démontable; disponible de 32mm jusqu'à 65mm.

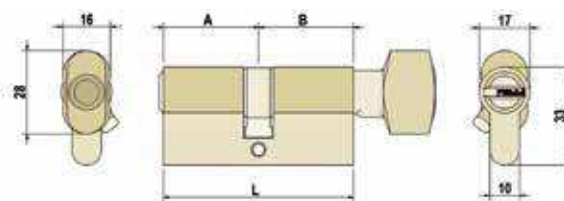

Cilindro con vástago para pomos y muletillas
Double cylinder with thumbturn shaft
Cylindre à tige pour boutons

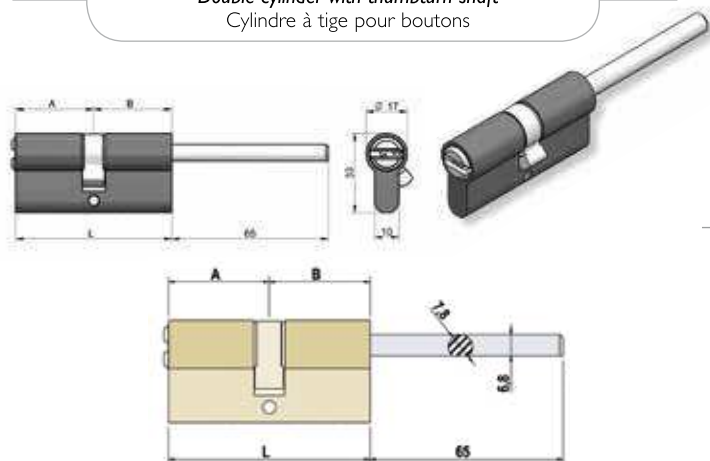

Disponible con botón pequeño - en la referencia sustituir la letra "B" por la "K"
Also available with small knob. Please substitute the "B" by a "K"
Disponible aussi avec bouton petit. Veuillez remplacer le "B" par un "K"

Cilindro extensible
Adjustable cylinder for panic bars
Cylindre réglable pour des bars antipanique

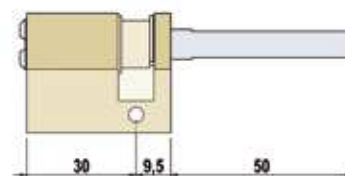

■ Latón, Brass, Laiton ⊙ Niquelado, Nickel plated, Nickelé ■ Bronce inglés, English bronze, Bronze anglais